

SolidPool

The pool with peace of mind



The pool of your dreams!

Each project is unique !

First of all, your project is the subject of an on-site study with an experienced professional who will offer you the solution adapted to your environment and your lifestyle.

Then a clear quote, detailing each position, each service, each solution will be given to you and explained. No surprises, everything is clear and precise.

All sizes & shapes are possible!

*Each project
is unique
let's study yours
together !*

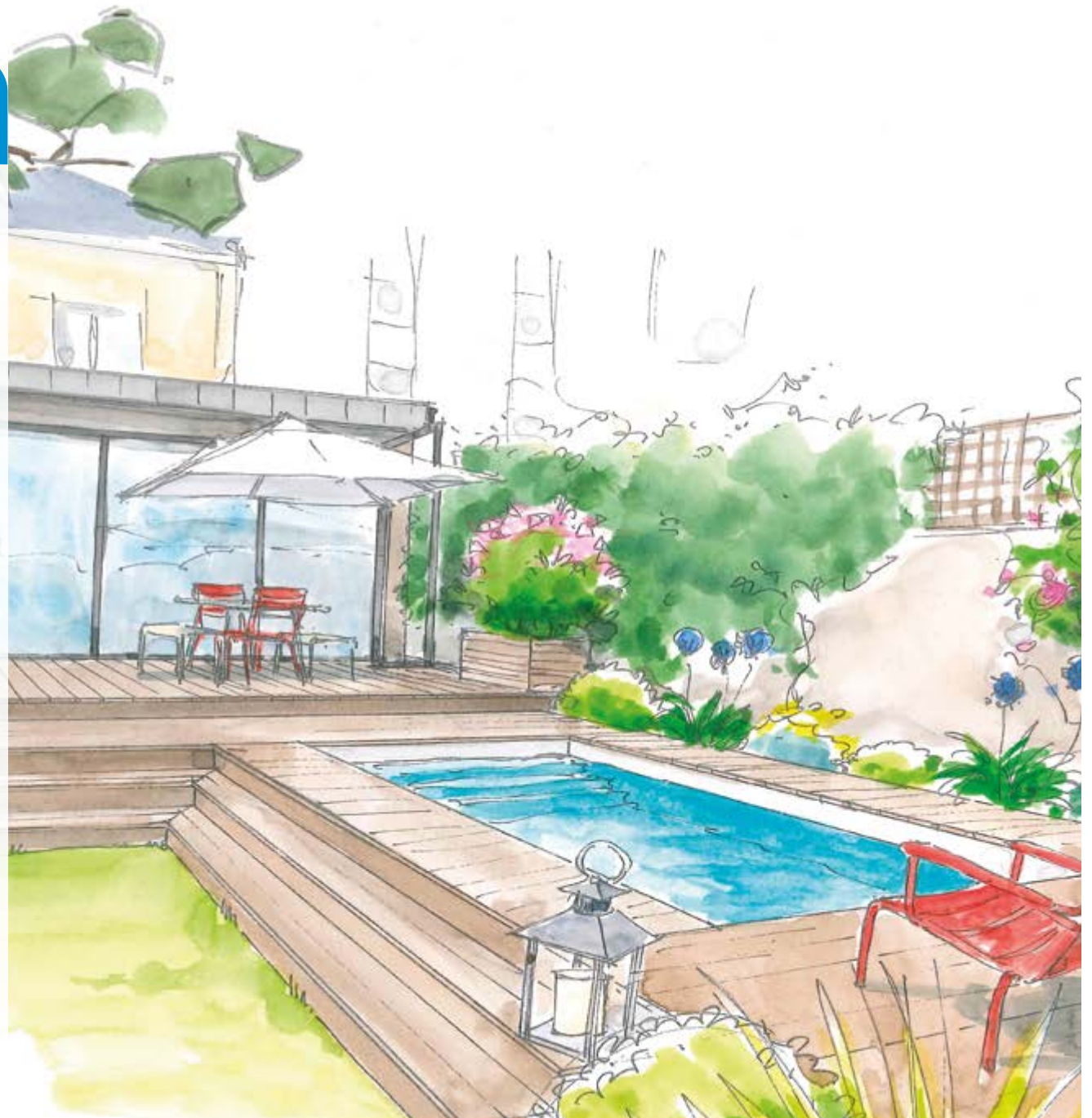



Technical teams

All trades working on your swimming pool are company professionals or regular subcontractors.

Regular technical upgrades as well as training courses are given to them every year so that the skills of our teams are always at the best level.

A precise schedule

A precise intervention schedule is established, our technicians will be present on the appointed days and will explain their service to you in detail.

Secure & clean construction site

For your comfort, our teams will always clean and secure the site at the end of the day.

Indestructible

A **SolidPool®** swimming pool is the guarantee of a swimming pool with walls entirely filled with concrete, no half measures!

***A SolidPool® swimming pool
it's 100% concrete, it's for life!***

Who are we ?

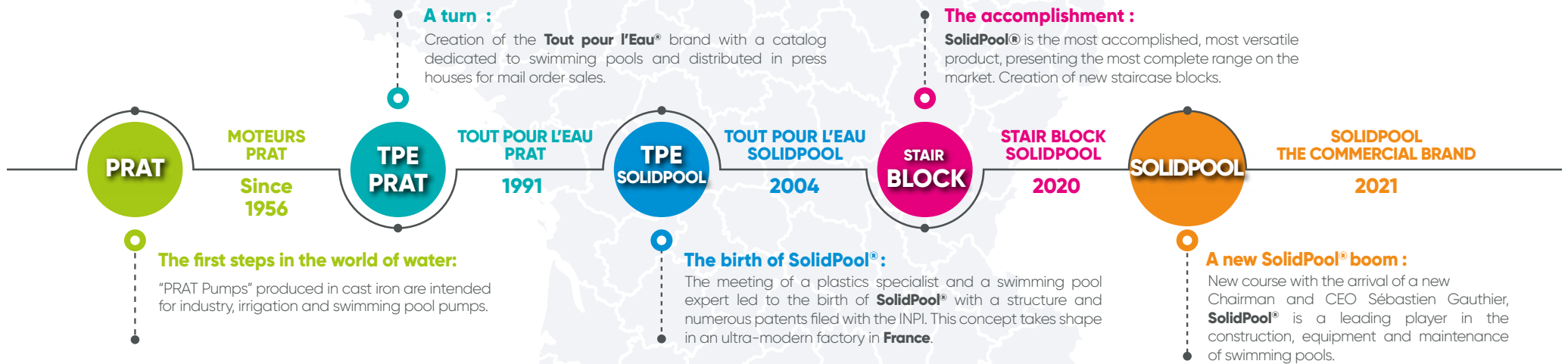

A constantly evolving network of affiliates!

... Some great achievements from our affiliates across our entire network.

↑
100%
Concrete

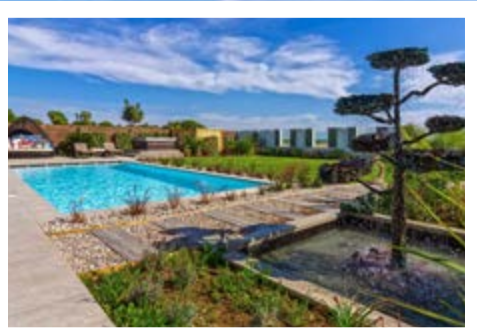

SOLIDPOOL - ORBRO - UK

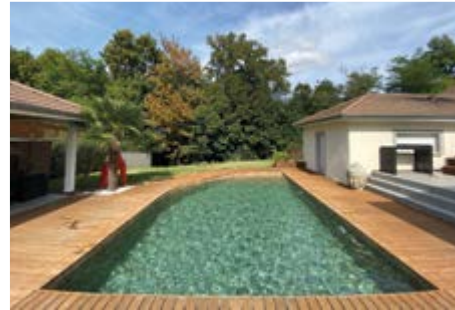

SOLIDPOOL - GE3M - 38-FR



SOLIDPOOL - SOLIDPOOL (Mauritius) LTD - MU



SOLIDPOOL - PISCINE EN SCENE - 35-FR

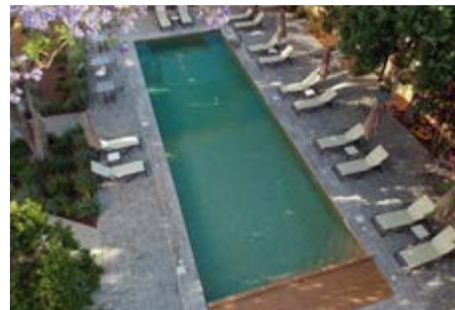

SOLIDPOOL - PISCINITY - GR



SOLIDPOOL - JULES & EAUX PISCINES - 87-FR



SOLIDPOOL - AQUAFAB - CA



SOLIDPOOL - THEVENY - 77-FR
Crédit photo : ève ohana



SOLIDPOOL - FMC SENEGAL - SN

The SolidPool® structure

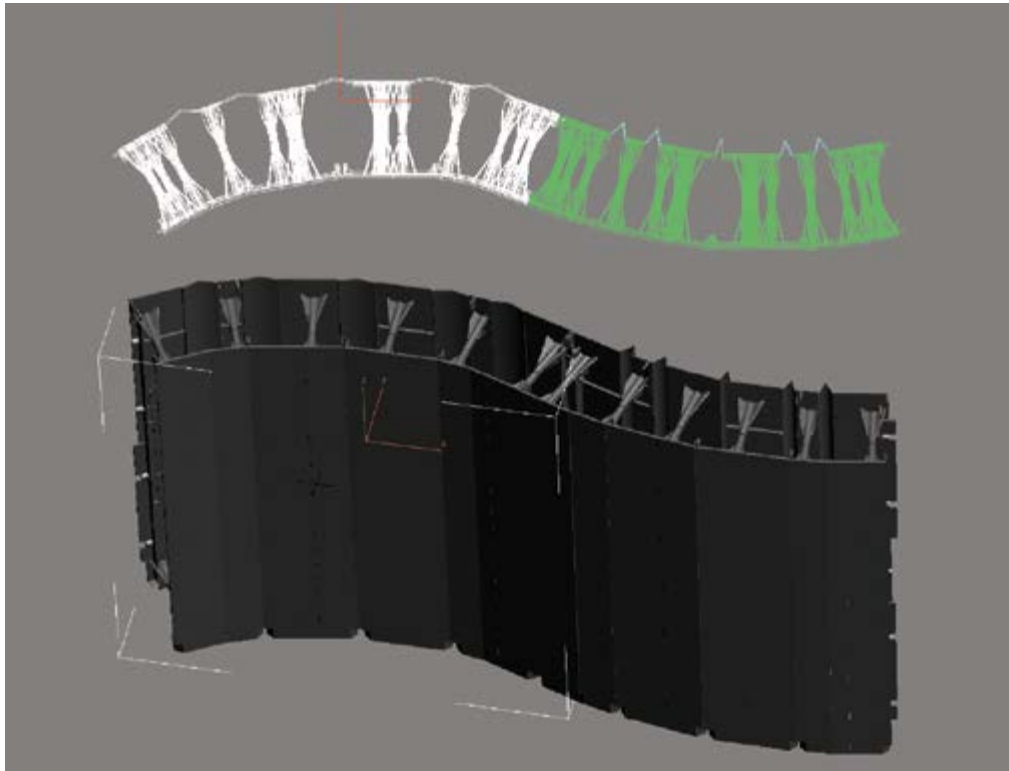

What is
the **SolidPool®** structure ?



“ 40 YEARS of expertise ”

For 40 years we have been “swimming” in the pool. (Construction traditional, steel swimming pool kits, resin swimming pool kits, polyester hulls, as well as swimming pools with coated coverings, and tiled swimming pools etc...)

Our experience, the suggestions of our professional customers and the meeting with an exceptional and experienced plastics manufacturer we allowed us to develop our **SolidPool®** structure.

We wanted a **french product** (Studies, molds and injection) and an **eco-responsible** swimming pool kit solution : Using regenerated PP (regenerable indefinitely) bring reliable swimming pool kits to the markets, **easy to climb and indestructible!**

Research and development is fully carried out in **France** by our engineers and technicians!



An eco-responsible company!

Manufacturing "made in France"

A **low** carbon footprint. Recycling of excess plastic (mainly from the automotive industry) for the raw material of our building blocks.

A **desire** to offer consumers equipment packs. A strict choice of partners sensitive to **ecology**. **A team of experts at your service**

**...BE EVER CLOSER
FROM YOU.**

Thanks to a constant investment policy, we have today tools at the cutting edge of technology which make it possible to manufacture approximately 5,000 **SolidPool®** swimming pool structures.



SolidPool in a few numbers!



277 Tons
recycled polypropylene



84 656 Blocks
of construction
in 2022



80% recycled plastic
corresponds to consumption
plastic from **5,769 homes**
in France per year

Manufacturing "made in France"

We came to manufacture our own swimming-pool structure in an ultra-modern factory based in France (80 km from our head office), with the requirements of efficiency and sustainability.

“ **EVERYTHING** is produced and assembled **ON SITE..** ”



The SolidPool® structure

REPRESENTATIVE PLAN OF A SolidPool® structure

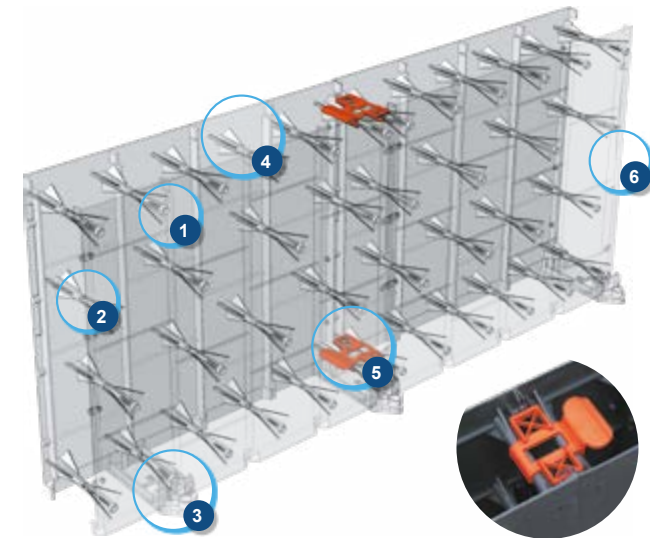
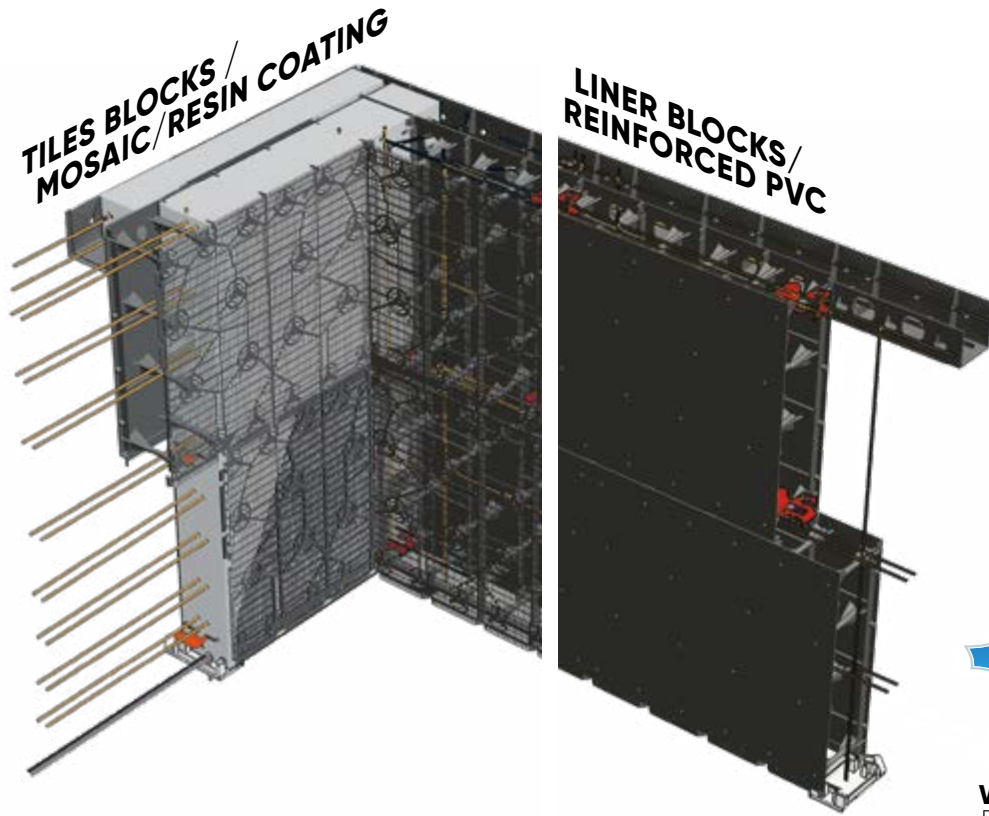

Why is this structure so exceptional?

- 1 A solid and durable structure:** the metal assembly inserts (located in the middle of the spacers) guarantee the exceptional solidity of the structure, allowing it to be poured with the concrete pump in a single pouring.
- 2 Finishes & precision:** the reinforcements of the panel junctions (spacers) improve the flatness of the panel faces (which allows an almost invisible junction of the panels between them, for a better surface condition).
- 3 An easy level structure:** SolidPool sole accessory allow the structure to be easily leveled.
- 4 100 % concrete!** These reinforcements have been

studied to allow optimum filling of the panels with concrete, in fact the connectors act like a concrete blade mixer by separating and evenly distributing the concrete.

- 5 Simply assembled using Clips!** The blocks come with red ed and self-locking and self-locking clips alignment. The blocks are securely held between them thanks to the clips. They make it possible to obtain a rigid, "one-piece" and straight structure!
- 6 Cleanliness of surfaces:** the side tabs allow the panels to be assembled vertically, they are designed to avoid concrete leaks between the panels and allow "clean" filling.

The 100% concrete solution!

Assembly & pouring
structure in 1.5 days

Easy to install stairs
in a few minutes.

100% compatibility
with all market equipments.

A quick achievement!

How ?

With our expertise, our patented technology and regularly trained qualified personnel!

In fact, our patented **SolidPool®** structure has been designed to simplify and control assembly, guaranteeing greater reliability and clean construction sites.



WHILE BEING 100% CONCRETE!



COUNT

2 to 3 days

for these steps,
then 3 weeks
drying....

The SolidPool® concept

The SolidPool® concept is a formwork guaranteeing a 100% reinforced concrete swimming pool.

This French industrial process allows:

- 👉 A clean and fast construction site
- 👉 A competitive cost
- 👉 A modular and indestructible swimming pool

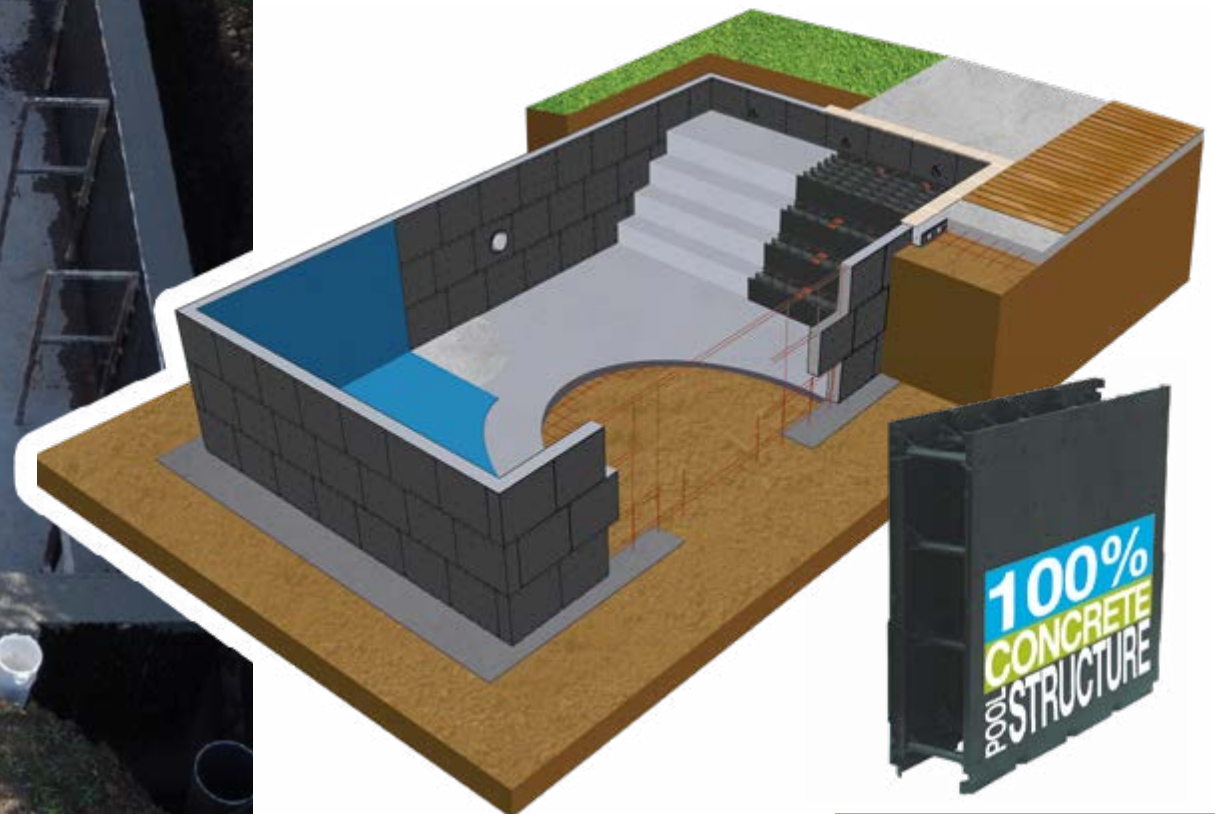

SolidPool Blocks:

Standard Block



Dimension :

Standard block : 60,5 x 15 x 55,5 cm

Small block : 60,5 x 15 x 42 cm

Tiles Block



Dimension :

Standard block : 60,5 x 15 x 55,5 cm

Small block : 60,5 x 15 x 42 cm
(available in 2 versions, block ready to tile 1 side and 2 sides)

Flex block



Dimension :

Block : 60,5 x 15 x 55,5 cm
(block available in one size in liner version or 1-sided tile finish)

The Ready to Dive Pool

A turnkey project: it's also...

- Administrative procedures
- Earthworks
- Construction of the swimming pool
- A ten-year guarantee*
- Exterior design

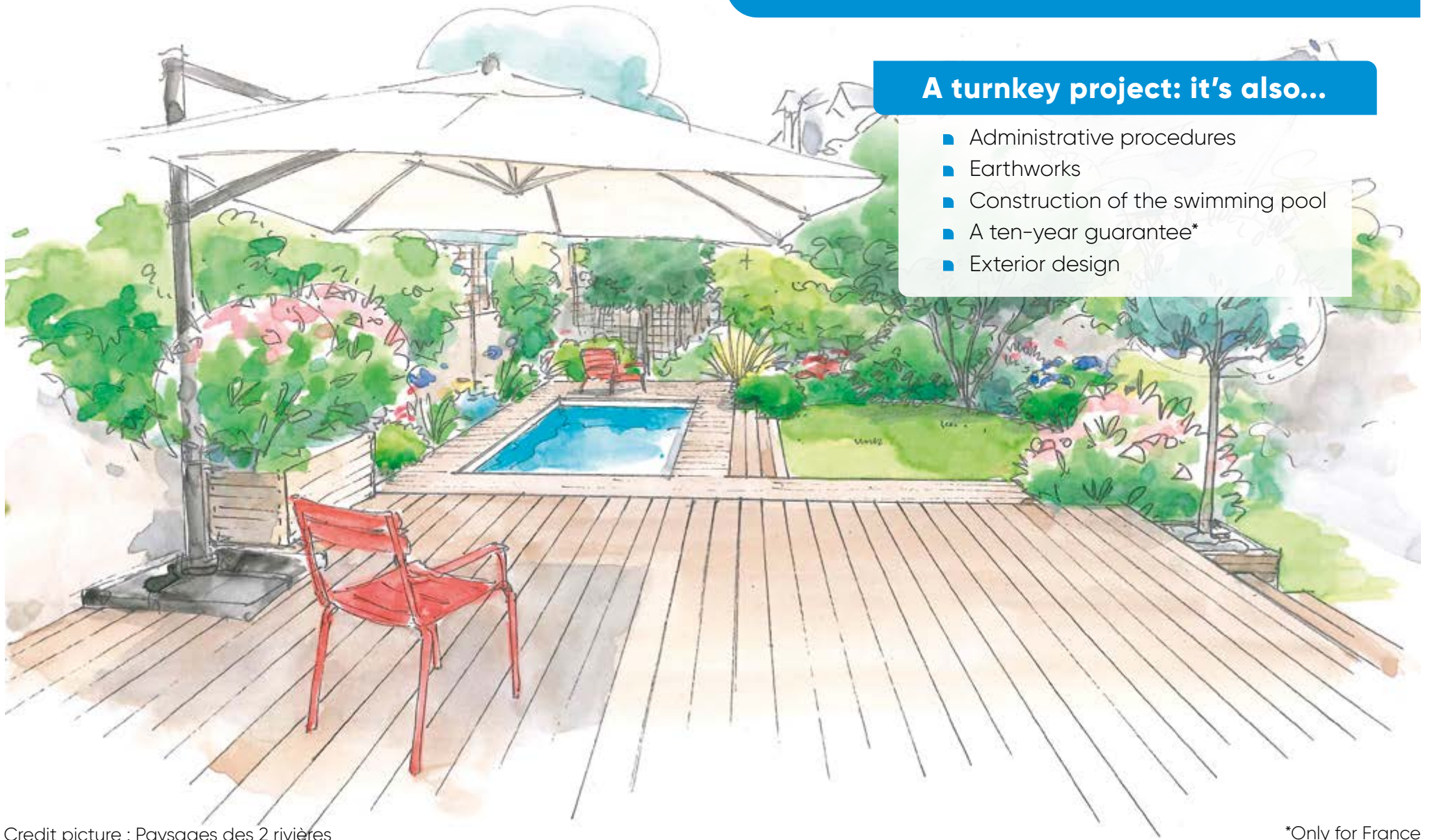

Credit picture : Paysages des 2 rivières

*Only for France

Standard size*:

2,27 x 4,09 m

2,88 x 5,30 m

2,88 x 5,90 m

2,88 x 6,50 m

2,88 x 7,11 m

3,48 x 7,11 m

3,48 x 7,72 m

3,48 x 8,32 m

3,48 x 8,93 m

4,09 x 8,32 m

4,09 x 8,93 m

4,09 x 10,14 m

4,69 x 9,53 m

4,69 x 10,14 m

5,30 x 10,14 m

5,90 x 11,95 m

...

Depth* :

from 1,10 m to 2,17 m

* These values remain indicative



The "Classic"

Balanced dimensions with a homogeneous swimming surface. Modern and timeless at the same time.

Goes easily with all styles. An interior staircase and a constant slab will optimize the relaxation, swimming and play area.

Very comfortable swimming pool.





Standard size*:

2,88 x 8,93 m

2,88 x 11,35 m

2,88 x 11,95 m

3,48 x 11,35 m

3,48 x 11,95 m

4,09 x 11,95 m

...

Depth* :

from 1,10 m to 2,17 m

* These values remain indicative



The "swimming lane"

Need to surpass oneself, need to maintain its shape, or simple aesthetic desire...

The swimming lane: being able to swim comfortably, alone or with family.



Standard size*:

2,88 x 2,88 m (-10m²)

4,09 x 4,09 m

5,30 x 5,30 m

5,90 x 5,90 m

6,50 x 6,50 m

7,72 x 7,72 m

...

Depth* :

from 1,10 to 2,17 m

* These values remain indicative



The "Carré Décor"

Laugh, move, play, the decor square is the most user-friendly swimming-pool type.

To choose with a corner staircase, to use its entire surface with family or friends. A constant slab will be a real plus for games.





Standard size*:

2,27 x 4,09 m (-10m²)

2,88 x 2,88 m (-10m²)

2,88 x 3,47 m (-10m²)

...

Depth* :

from 1,10 to 2,17 m

* These values remain indicative

The "Mini Decor"

Compact, adapts to all environments, even the smallest.

Magnifies all spaces, nestled in a courtyard, between two walls or even in a basement.

Our Mini Decor requires no formality prior, it is not subject to any regulation special.



Standard size*:

All sizes,
above ground,
semi-underground,
completely underground
free forms...

Depth* :

from 1,09 m to...



* These values remain indicative

"Tailor-made"

Modernism of forms and integration are the key words of these swimming pools.

The constant slab will be more comfortable, it optimizes the swimming and play area.



The SolidPool® structure

2 blocks heights... a multitude of depths

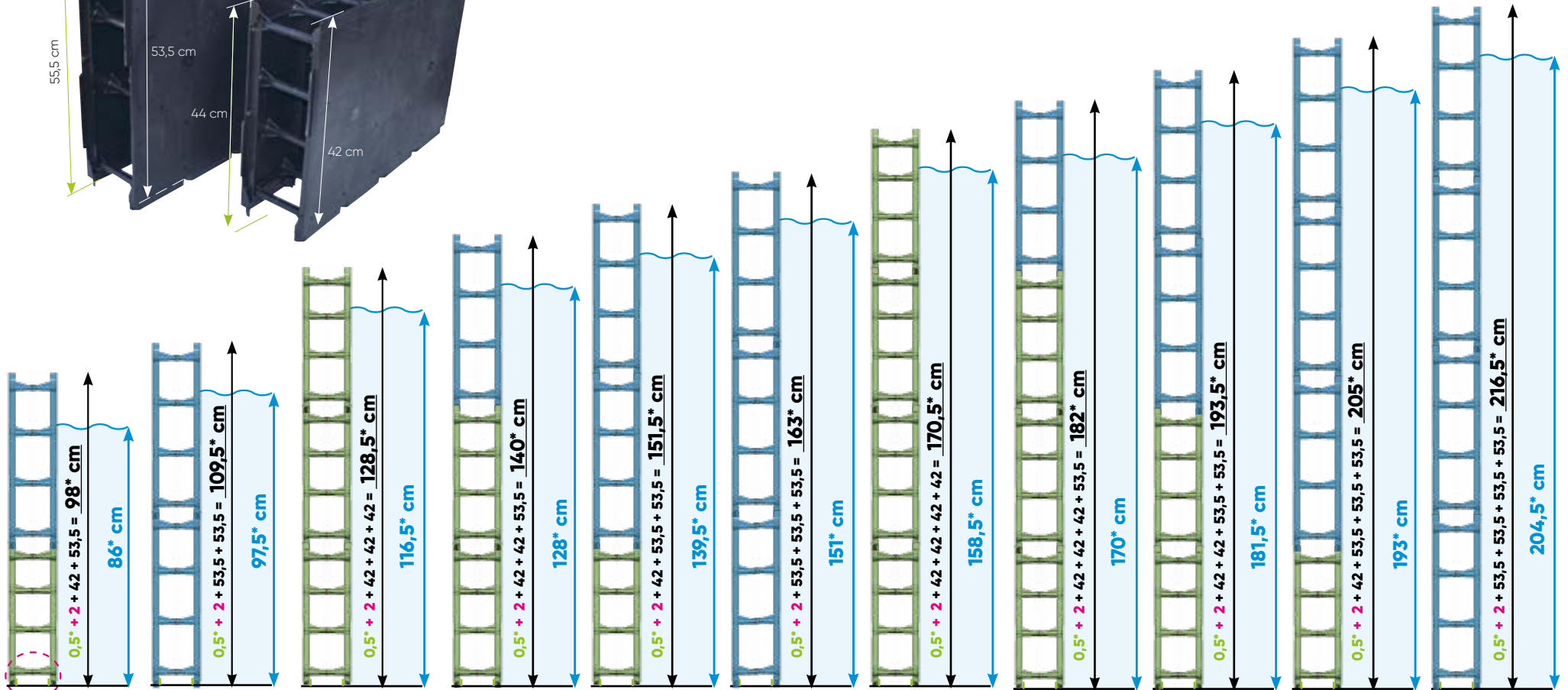
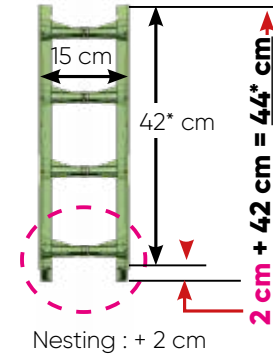
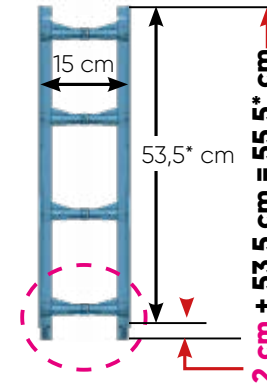

WARNING on the entire periphery of the same row the blocks must be of the same height (53.5 cm or 42 cm)

* These values remain indicative

FLAT SLAB:

Height at base 1,28 - 1,40 - 1,51 - 1,63 m ...

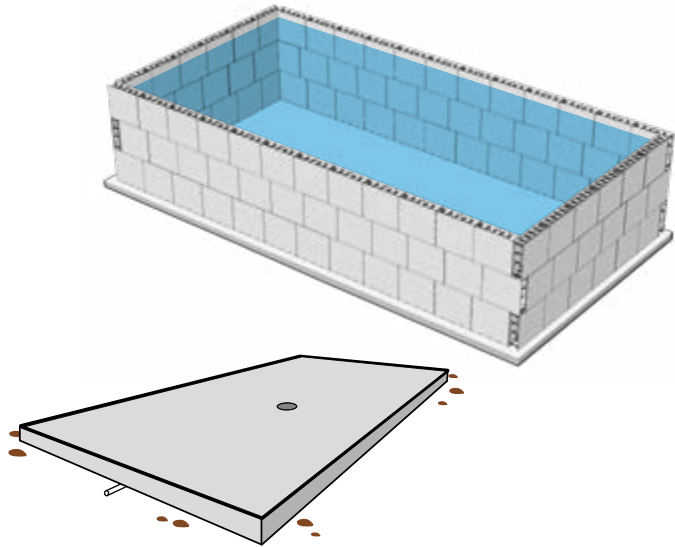

The flat slab is the most comfortable and friendly for the whole family.

MOST:

The flat bottom is the most versatile solution and safe if you like to swim or play.

SolidPool® pool floor type

DIFFERENT SLAB DEPTHS:

Height at base 1,10 m to 2,17 m

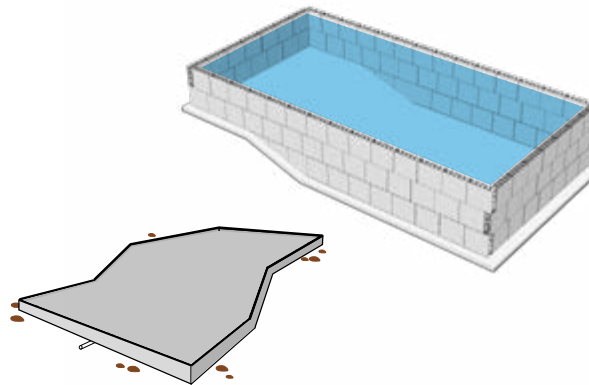

MOST:

Provides a play area for children and an area for swimming.

PYRAMID DEPTH:

Height at base 1,10 m to ...

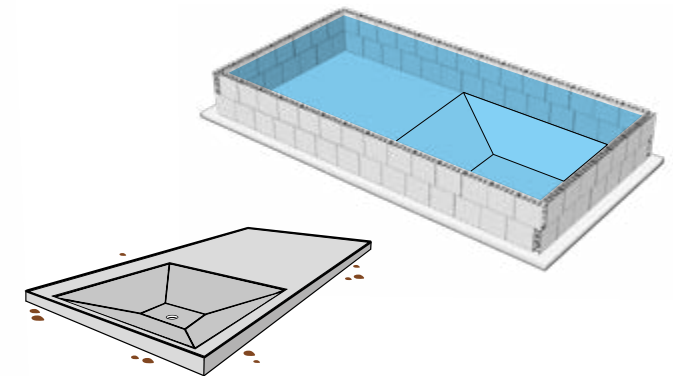

MOST:

Benefits from a deeper area to facilitate dives and avoid touching the bottom.

FIND ALL OUR VIDEOS ON

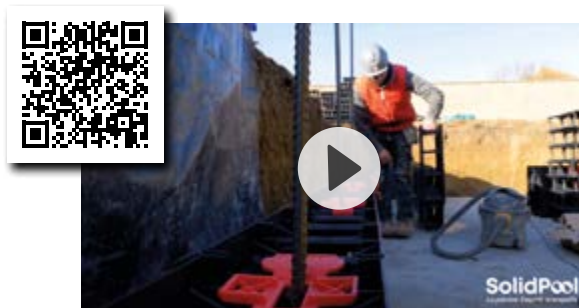

Our steps models :





The steps

The staircase is more than access to your swimming pool, it is also a place of relaxation and conviviality, it is the finishing touch to your swimming-pool

**Simple and refined,
standard or sophisticated,
You choose.**

Standard dimensions:

All sizes, all shapes.

Liner/Reinforced PVC finishes

Liners 75/100

The liner is the most used solution for waterproofing swimming pools!

In black and gray, it will dress your swimming pool in a zen and elegant shade.

In Blue and Green, it will bring you the tranquility of timeless radiance.

Sand and white, it will transport you to the islands with crystal clear and turquoise waters, what a journey



White

Reinforced PVC 150/100

Reinforced PVC is particularly suitable for indoor swimming pools, with complex shapes and pools with high traffic.

The different installation and welding technics welding allows it to be adapted to everything most complex type of pool shapes.

Some protections and varnishes protect the coating against stains and discoloration, they are also treated: antifungal, anti-UV and anti-bacterial. Also available for certain anti-slip models.



Sand

*and many other models
see catalog!*



Light gray



Dark grey



Light blue

Pool with technical room:

Sand or cartridge filter

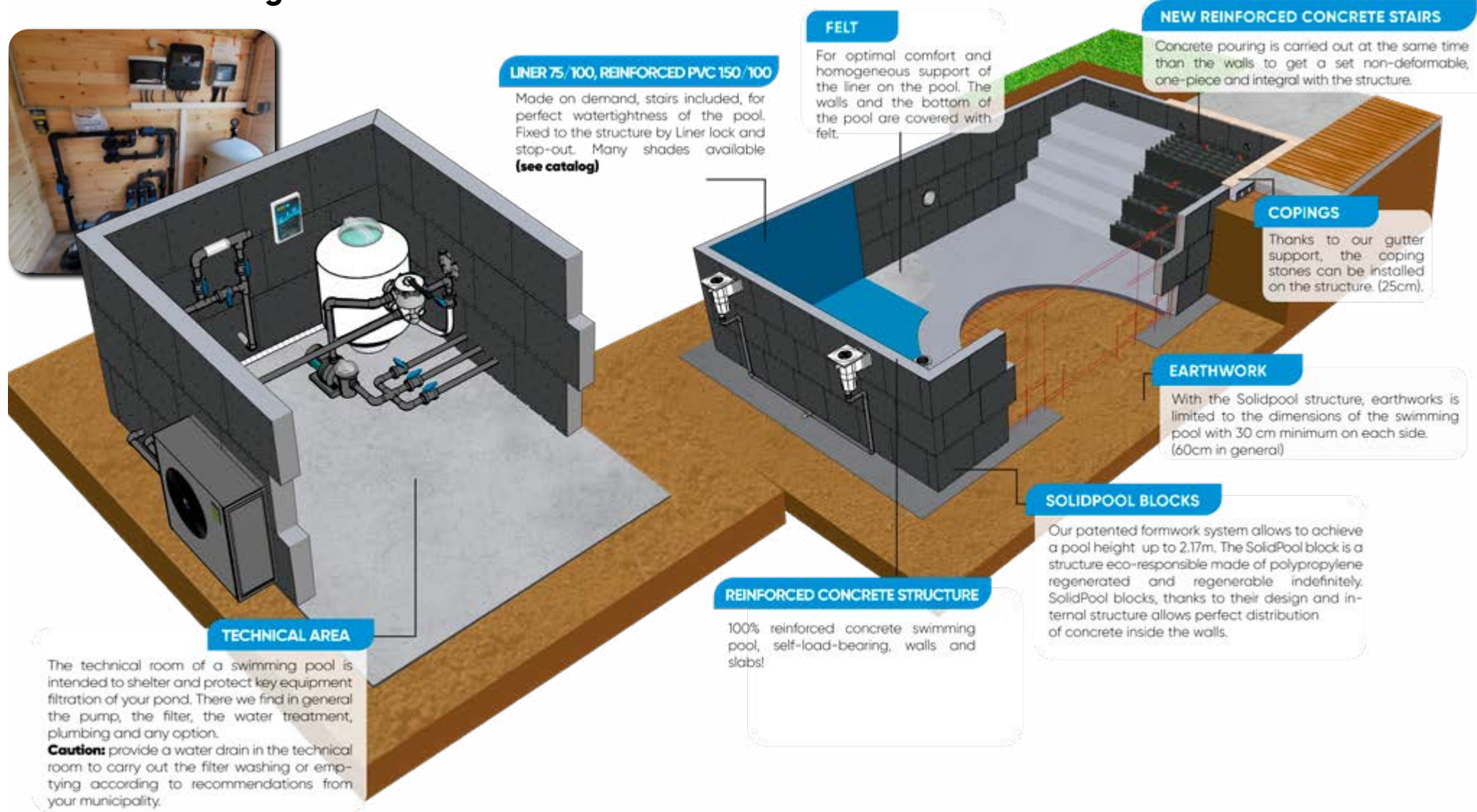

Pool with compact filtration unit :

Integrated cartridge filtration

Compact filtration unit which fits completely into its environment.

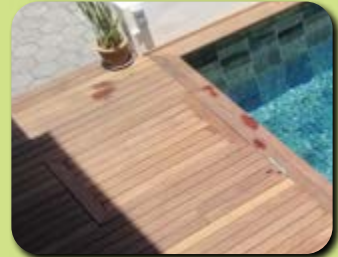

LINER 75/100, REINFORCED PVC 150/100

Made on demand, stairs included, for perfect watertightness of the pool. Fixed to the structure by Liner lock and stop-out. Many shades available (see catalog)

FELT

For optimal comfort and homogeneous support of the liner on the pool. The walls and the bottom of the pool are covered with felt.

NEW REINFORCED CONCRETE STAIRS

Concrete pouring is carried out at the same time than the walls to get a set non-deformable, one-piece and integral with the structure.

COPINGS

Thanks to our gutter support, the coping stones can be installed on the structure. (25cm).

EARTHWORK

With the Solidpool structure, earthworks is limited to the dimensions of the swimming pool with 30 cm minimum on each side. (60cm in general)

SOLIDPOOL BLOCKS

Our patented formwork system allows to achieve a pool height up to 2.17m. The SolidPool block is a structure eco-responsible made of polypropylene regenerated and regenerable indefinitely. SolidPool blocks, thanks to their design and internal structure allows perfect distribution of concrete inside the walls.

REINFORCED CONCRETE STRUCTURE

100% reinforced concrete swimming pool, self-load-bearing, walls and slabs!

TECHNICAL ROOM: FILTRATION UNIT

The compact filtration unit can equip swimming pools up to 60m³ or more by adding a second unit.

This is the solution:

- **the simplest** : the room is attached to the wall!
- **the most aesthetic**: a discreet opening, everything is harmonious.
- **the most reliable**: everything is accessible and visible simply: pump (high efficiency and high temperature), piping...
- **the quietest**: sound insulation of filter wall with double skin on the opening...
- **the most scalable**: heating, electrolysis...

Compact filtration unit "SUPREME"

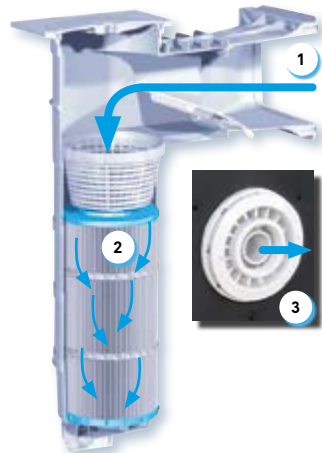

Filtration is ensured by a large capacity cartridge, with a filtration fineness of $15\ \mu$ on a filtering surface of $7.5\ \text{m}^2$ compared to $50\ \mu$ with sand filtration.

1) The skimmer ensures water drainage.

The swing flap traps wastes. The water passes through the skimmer basket which is equipped with a pre-filter intended to stop the largest impurities (needles, leaves, etc.). It is recommended to use a sock on the pre-filter in order to capture the finest particles (in this case put the roller in the basket before the sock).

2) The water is then filtered with a fineness of $15\ \mu$!

It is strongly recommended to check the cartridge for cleaning on a weekly basis. If using a flocculant, make sure you have the product suitable for a cartridge filtration (not all flocculants are compatible).

3) Filtered water has a flow rate of $15\ \text{m}^3/\text{h}$ and is returned to the pool through the spa nozzle with double venturi for an increased flow rate of up to $30\ \text{m}^3/\text{h}$ with the opening of the air control!

Dynamic mixing over the entire volume of the pool



Flow increased thanks to the venturi effect: **from $15\ \text{m}^3/\text{h}$ to $30\ \text{m}^3/\text{h}$**

- **Discretion:** fits perfectly
- **Economy :** water, energy, chemistry
- **Filtration optimization**

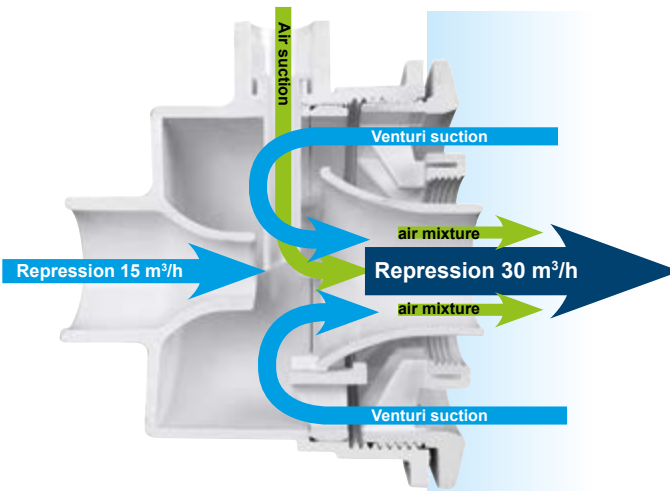

Filtration function

The double venturi nozzle allows us to increase the mixing of the water up to $30\ \text{m}^3/\text{h}$, which gives us exceptional performance!

With integrated massage

By opening the air control button (**2**), the nozzle will suck in air to mix it at the nozzle outlet for optimum relaxation

The compact filtration unit "SUPREME"

"Supreme" filtration wall available in liner/reinforced PVC finish version and tiles version

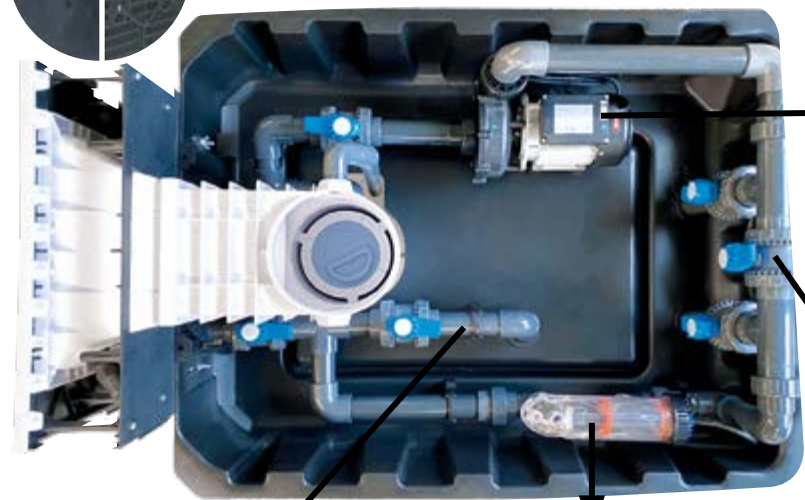
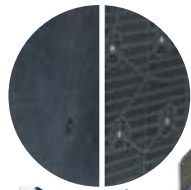

PHT pump:
High efficiency:
PHT 15 800W, 15m³/h.

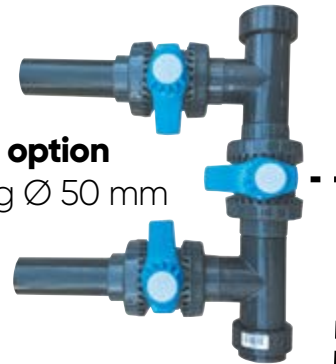

Bypass option
Heating Ø 50 mm



Bypass valve option
Ø 50 mm for delivery
deported or cascade



Electrolyser option
PRO S 60 Remote box
Cell extension 10 m.
Cell extension 20 m.



Order boxes

(filtration, electrolisis system, shutters...) have to be deported from the pool supply.



Heat pump

deported from preference of 3 to 15 meters

The NCC wall:



Counter-current system

Offers you the opportunity to enjoy [even more] your pool, you will have to face a strong current of water which will allow you to swim without any limits, without moving and regardless of the size of your pool.

The device controls are activated from within the pool itself. The on/off switch is pneumatic, the large diameter air intake provides a powerful, more sparkling and relaxing jet.

Massage hose option

SolidPool® staircase

Perfect shapes and finish!

Easily create a staircase with steps filled with reinforced concrete, reinforced by concrete pillars, linked to the structure of the swimming pool.

Perfect step edges, with no coating required.



1 Stair block



2 Beach block



3 Support

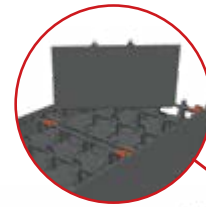

Depending on the desired water height, on the beach, a corner step will be added to facilitate access to the pool.

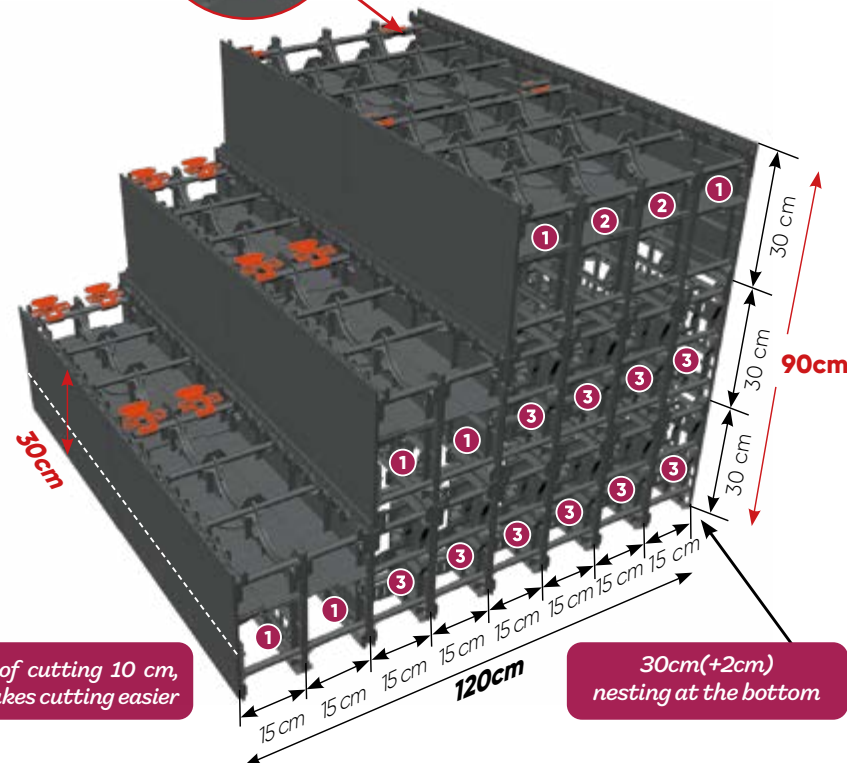

Possibility of cutting 10 cm, a layout makes cutting easier

30cm(+2cm) nesting at the bottom

1

SOLIDPOOL® STAIRCASE HALF-BLOCK. 30 CM HIGH, 15 CM DEEP, LENGTH 60 CM. (with interlocking)

2

SOLIDPOOL® BEACH HALF BLOCK. 30 CM HIGH, 15 CM DEEP, LENGTH 60 CM. (with interlocking)

The beach half-block allows you to create the beach width of your choice in multiples of 15 cm.

3

SOLIDPOOL® BACKING. 30 CM HIGH, 15 CM WIDE DEPTH, LENGTH 15 CM. (with interlocking)

SolidPool® is also...

a swimming pool that meets your desires !



A photograph of a rectangular swimming pool with clear blue water, surrounded by a concrete deck. The pool is set in a lush, green backyard with trees and a house in the background. A blue rounded rectangle is overlaid on the top part of the image, containing white text.

Find us on
www.solidpool.com

Contact us

✉ contact@solidpool.com

🖱 www.solidpool.com



SolidPool

The pool with peace of mind